

S200 INSTALLATION PREP GUIDE

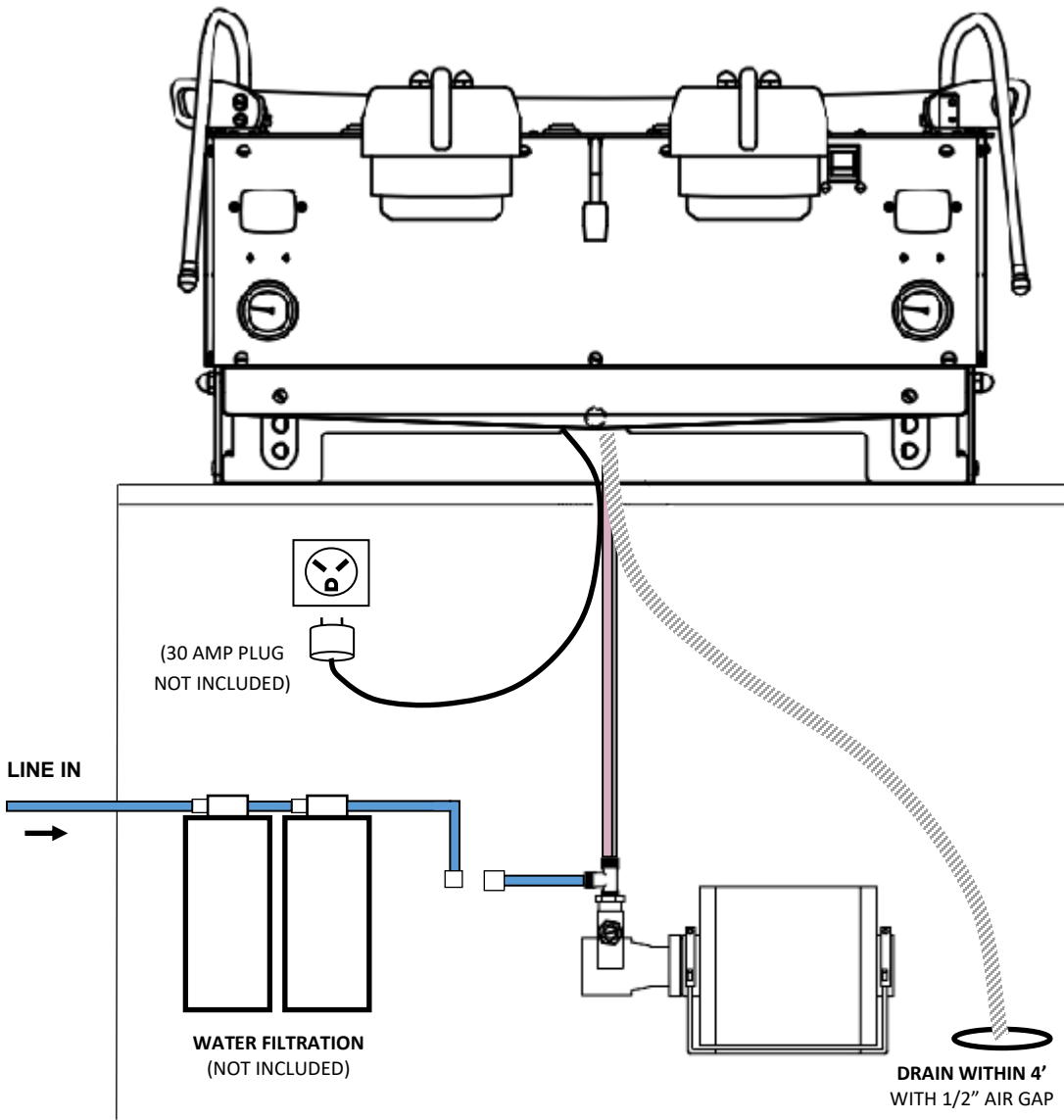

**REMOVING LOWER BACK PANEL AND RIGHT SIDE PANEL WILL REVEAL ALL WATER LINE ORIGINS

LEGEND

- WATER
- PUMP PRESSURE TO COFFEE TANKS
- LINE PRESSURE TO STEAM TANK
- DRAIN

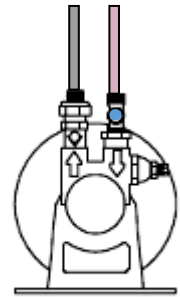

SIDE VIEW OF PUMP

QUICK REFERENCE SPECIFICATIONS

DIMENSIONS: 17"/428mm (H) 28"/702mm (W)
24"/597mm (D)

WEIGHT: 152 lbs/69 kgs

ELECTRICAL: 220V/28A

PLUMBING: Line pressure of 50psi (minimum)

FITTING: 3/8" compression w/ shut off

DRAINAGE: Within 4 feet of machine

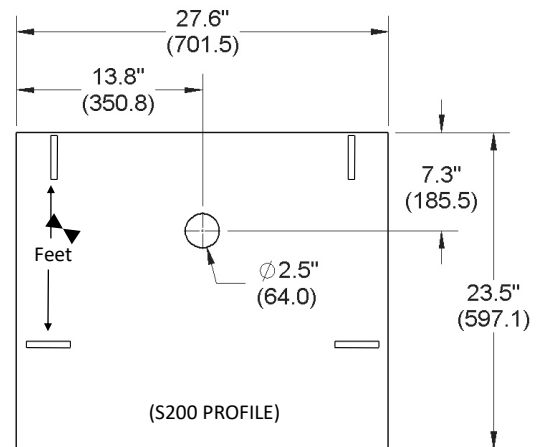

TOP DOWN VIEW OF COUNTER TOP

FOR COMPLETE INSTALL INSTRUCTIONS, PLEASE REFER TO THE TECHNICAL MANUAL