







(*) WiFi module during the year 2023

Characteristics

- 

MIXED INFUSION HOT WATER FOR TEA AND HERBAL TEAS
Immediate mixing of cold / hot water for a better chemical and organoleptic quality.
- 

LED LIGHTING OF THE WORK AREA
Allows efficient working in any condition of environmental lighting.
- 

ENERGY SAVING SYSTEM
Component insulation and smart electronics for maximum energy efficiency.
- 

AUTO-ON, AUTO-OFF AND DAY-OFF FUNCTION
Programmable ON-OFF/ON-ECO timer for each day and/or daily timetables.
- 

TEMPCONTROL
For a very-high thermal stability (± 0.2 °C).
- 

EASY SERVICE
Fast access to the internal parts for quick and easy technical service.
- 

GROUP FLUSHING
With a simple pressure of the button a small quantity of water is dispensed to allow the group to be always clean.
- 

STAINLESS STEEL COFFEE BOILER
Guarantees excellent stability and thermal precision, associated with resistance to oxidation and limestone.
- 

AUTOMATIC CLEANING CYCLE
Process for coffee group cleaning.
- 

VOLUMETRIC PUMP
A new generation of pump to amplifying your experience

Versions

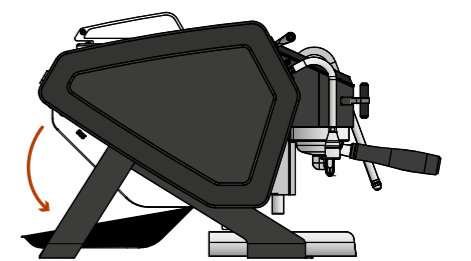
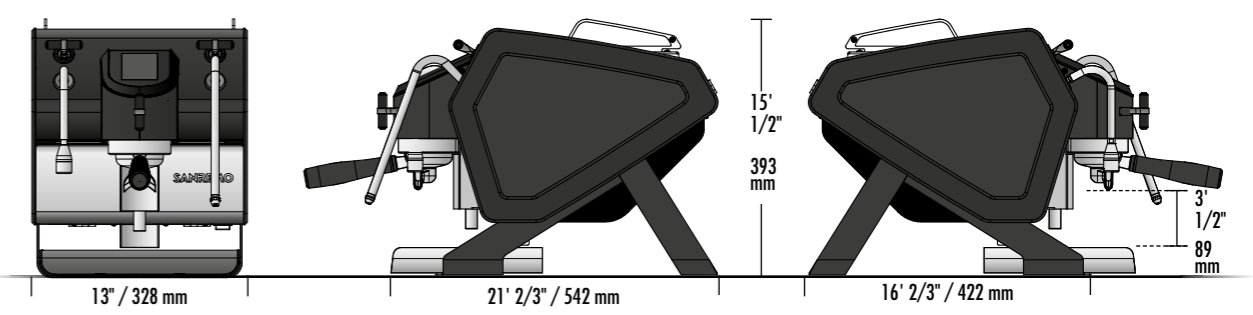

Technical data

voltage/max input boiler	V	120V 50-60 Hz / 1.65 kW
coffee boiler's resistor power	W	500
steam boiler capacity	lt	1
coffee boiler capacity	l	0.5
net weight	lb / kg	70.5 / 32
gross weight	lb / kg	79 / 36

Colors

- 
Black: matt|glossy (side frames) RAL 9005
- 
White: matt|glossy legs and side RAL 9003 RAL 9005
- 
White: matt|glossy (side frames) RAL 9003

Customizations available, see YOU_KIT catalogue for more info.



You
Watch the video

Customizable presets

Extraction profiles customizable and savable:

- 6 standard profiles with optimal parameters presets
- 12 completely customizable profiles in all 3 extraction phases, with a capacity to disable pre-infusion and post-infusion the Paddle
- Set your manual profiles from the Paddle



Electronic paddle

Manually create your profiles.

Configure the Paddle (right/left) based on your gestures.

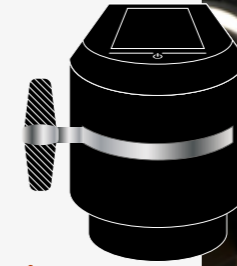

36

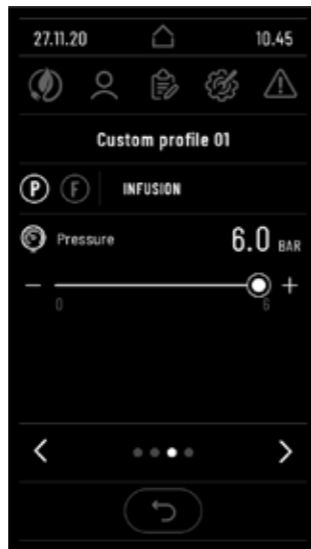

YOU
MADE FOR YOU BY SAHREMO



Extraction mode

Check your extraction in real time verifying pressure flow rate

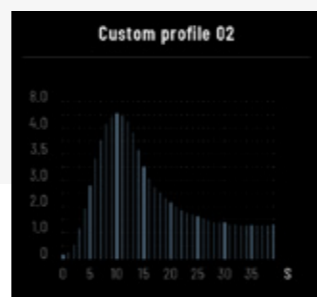
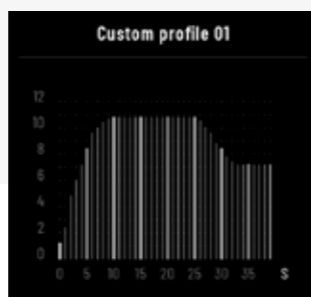
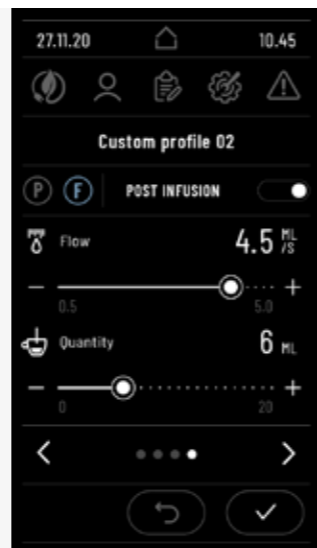
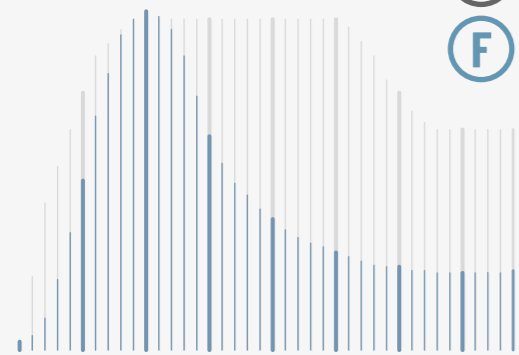

Energy efficiency



Setting:

- **Automatic:** allows the user to associate up to 6 daily time frames.
- **Manual:** allows the user to turn the machine or the individual boilers on and off manually.

Two programmable modes:

- **Stand-by:** low power consumption condition, compliant with the ErP Directive (2009/125/EC).
- **Eco:** keeps the machine on, but at a reduced temperature for quick start-up.

For both, the user can enable the Energy Saving function, which automatically turns the machine off after the set time.

