

NOTE:

1. DIMENSIONS IN PARENTHESIS ARE METRIC MILLIMETERS

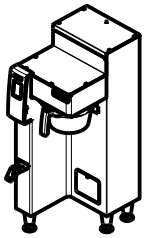

SCALE 0.031

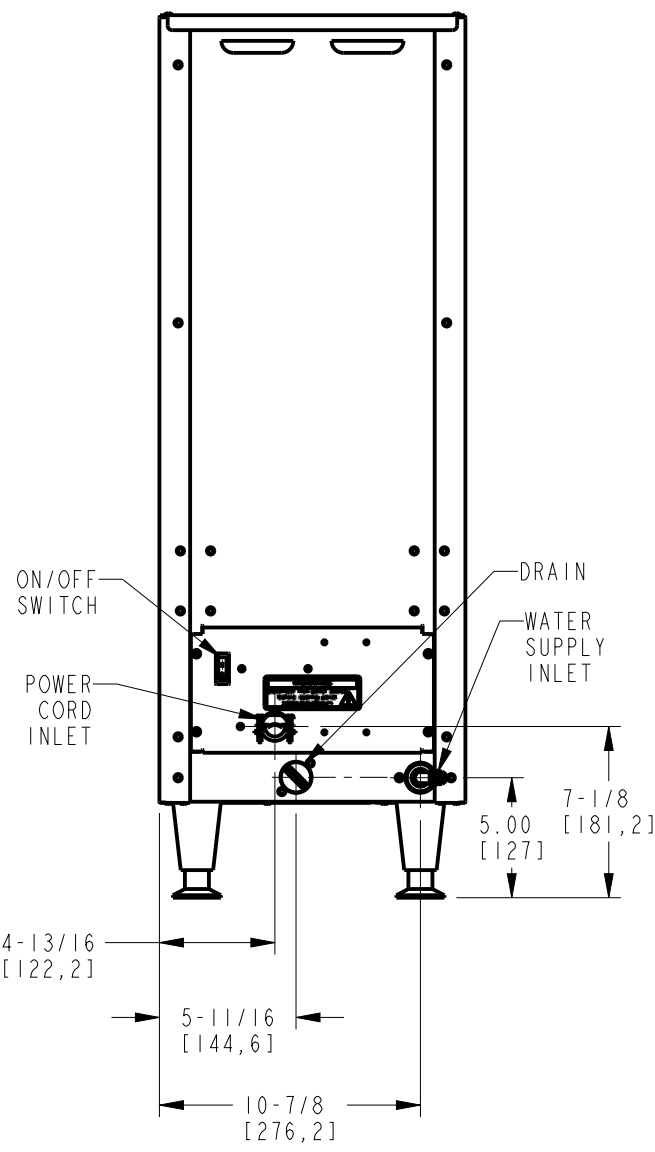
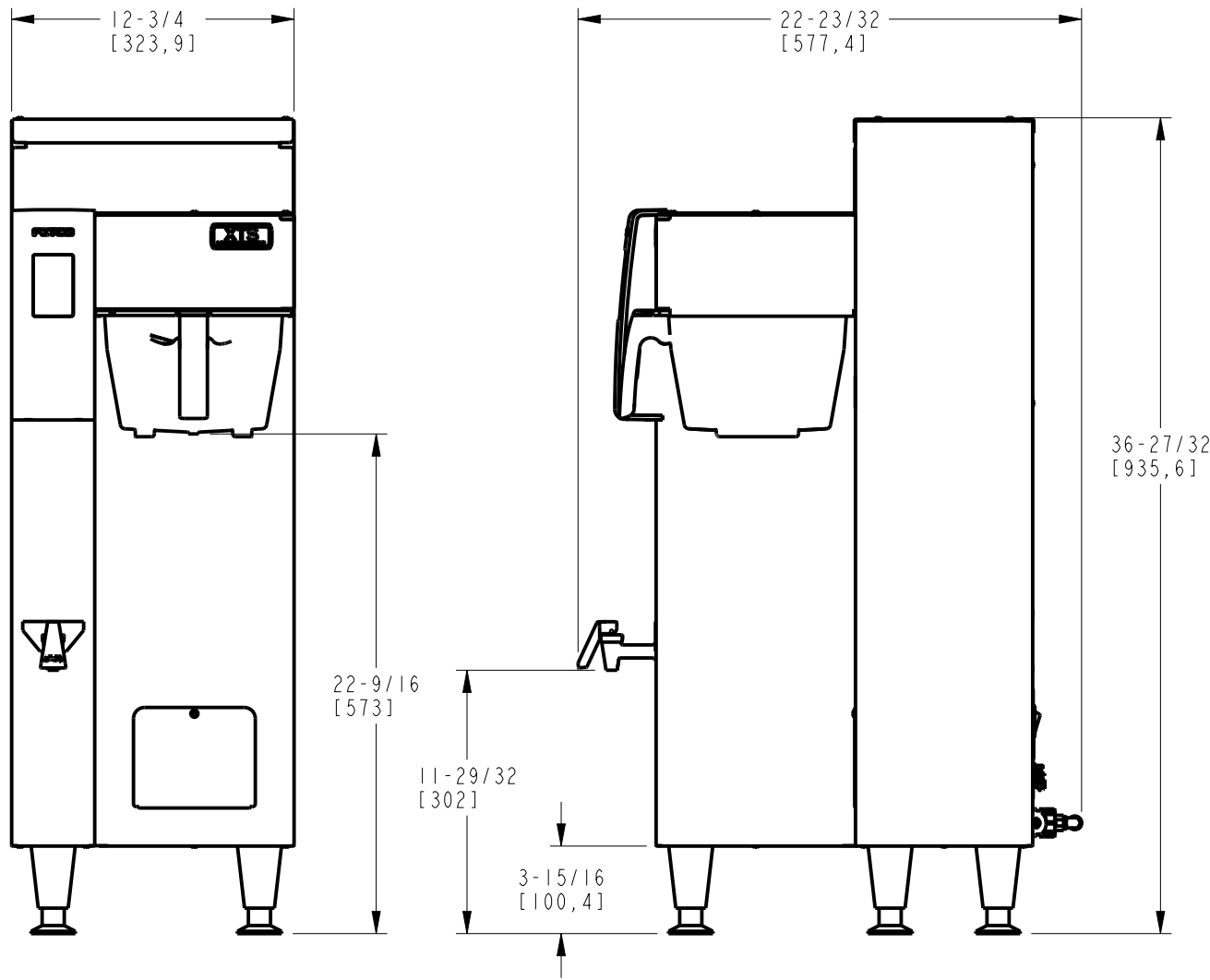

CBS-2151 XTS
SCALE 0.125
(REF.: 1101.00192.00)