

**BROOD**®

**DRNX MIX BY BROOD  
MANUAL**

SAFETY REGULATIONS	3
GENERAL INFORMATION	4
COMPONENTS	5
INSTALLATION	6
OPERATION	8
ADJUSTABLE SETTINGS	9
CARE	10
TROUBLESHOOTING	11
FAQ	12
WARRANTY	13
DECOMMISSIONING	14

**NEVER ALLOW WATER TO COME INTO CONTACT WITH ANY OF THE ELECTRICAL PARTS OF DRNX MIX: THERE IS A DANGER OF CREATING A SHORT CIRCUIT.**

## **INTENDED USE**

DRNX MIX is intended to be used in cafes, restaurants, and pantries. It dispenses liquid from any non-pressurized container by drawing liquid, infusing it with atmospheric nitrogen and chilling it to 2°C. Do not use liquids that are above room temperature or that are unfiltered. It must only be operated by a trained person. The appliance is not to be used by persons (including children) with reduced physical, mental or sensory abilities or with scarce experience and/or expertise, unless they are supervised by a person responsible for their safety, or they are instructed by this person on how to properly use DRNX MIX.

## **POWER SUPPLY**

DRNX MIX must be connected to the power supply in accordance with its specifications. Only connect it with the specified supply voltage.

## **POWER CORD**

Never use DRNX MIX if the power cord is defective. Report any defects in the cord and/or plug to the service provider immediately. Do not pass the power cord around corners, over sharp edges or over hot objects and keep it away from oil. Do not use the power cord to carry or pull it. Do not pull out the plug by the power cord nor touch it with wet hands. Do not let the power cord hang freely from tables or shelves.

## **FOR THE SAFETY OF OTHERS**

Ensure that children cannot play with DRNX MIX and/or the packaging materials. Observe the warning and safety instructions on the electrical components and in this manual. Improper use of DRNX MIX such as opening it during operation, incorrectly operating it, or not following standard guidelines for operating electrical equipment may lead to injury.

## **FIRE SAFETY PRECAUTIONS**

In case of fire, use carbon dioxide (CO<sub>2</sub>) extinguishers. Do not use water or dry powder extinguishers.

## **SUITABLE LOCATION FOR OPERATION AND MAINTENANCE**

DRNX MIX should be installed in accordance with the safety regulations in force at the time of installation. Operate it in an environment between 13°C and 32°C. Make sure it is in a dust-free environment. Avoid placing open flames and/or incandescent objects near it to avoid melting or other damage to the dispenser housing. If the dispenser has been exposed to such conditions, alert the service provider who will carry out a safety check.

## **STORING DRNX MIX**

If DRNX MIX is to remain inactive for a long time, turn it off and unplug it. Store it in a dry place, out of reach of children. Make sure the storage area is between 13°C and 40°C. Keep it protected from dust and dirt.

# SAFETY REGULATIONS

## GENERAL INFORMATION

### REPAIRS / MAINTENANCE

In case of failure, problems or a suspected fault resulting from a fall, immediately remove the plug from the power socket and alert the service provider or specialized technician. Never attempt to operate it if it is faulty. Please report any fault to your service provider. Only the service provider and/or technician may carry out servicing operations and repairs on DRNX MIX, unless otherwise informed. Any repair of the dispenser must be done only when it is switched off and it is ascertained that there is no electric current. All spare parts must be obtained from your service provider. Follow the service and maintenance instructions in this operation manual.

### USE

DRNX MIX pulls any filtered liquid from an unpressurized container. It chills the liquid to 2°C and infuses it with atmospheric nitrogen.

### VISCOSITY OF LIQUID

Ensure that your beverage has been filtered in order not to clog the pre-filter or if that has been bypassed, not to clog the machine. Thick liquids risk slowing down the liquid pump inside. DRNX MIX comes with a pre-filter that is already fitted onto the beverage tube. If the pre-filter is not attached, you can risk damaging components inside.

### BEVERAGE CONTAINER

Any non-pressurized container can be used depending on what is required. We recommend using the designated BROOD container (sold separately).

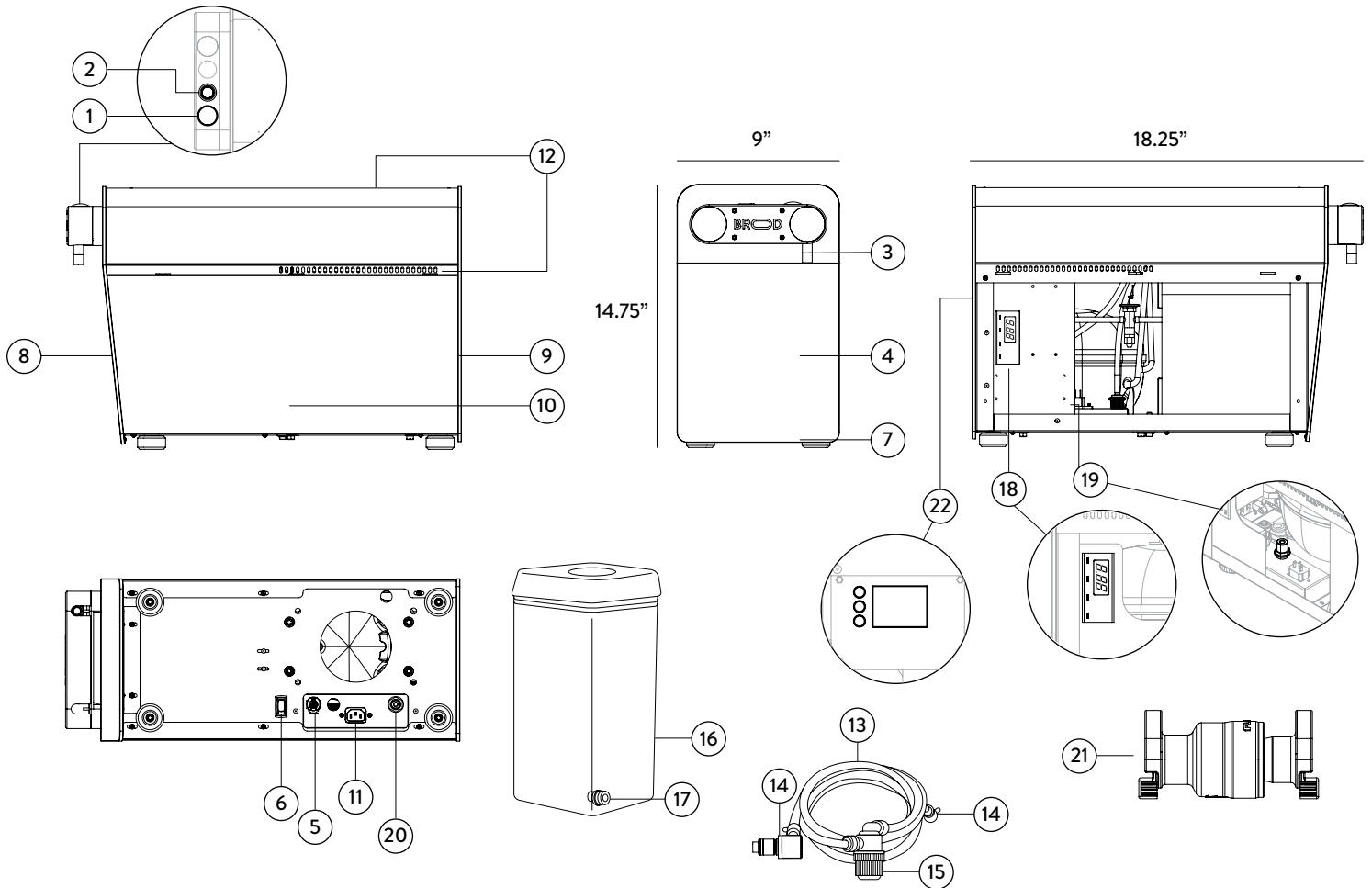

- 1 – Tap Button
- 2 – Infusion Button
- 3 – Nozzle
- 4 – Exterior
- 5 – Inlet Connector
- 6 – Main ON/OFF Switch
- 7 – Legs
- 8 – Forward Plate
- 9 – Rear Plate
- 10 – Side Panel(s)
- 11 – Power Cord
- 12 – Vents/Exhaust
- 13 – Beverage Tube
- 14 – Elbow Connectors
- 15 – Pre-Filter
- 16 – BROOD Beverage Container
- 17 – Inlet for Container
- 18 – Thermostat
- 19 – Calibration Knob
- 20 – Inlet Air
- 21 – Pressure Reducer
- 22 – Ratio Controller

## SPECIFICATIONS

Width: 9.00in	Power Supply: 100-120V/60Hz; 200-240V/50Hz
Height: 14.75in	Nominal Power: 334W
Depth: 18.25in	Amps: 3.5A
Weight: 77lbs	Refrigerant: R513a/200g
Dispensing Capacity: 1.7L/min (0.4gpm)	High Side: 300PSI/Low Side:60
Coffee Temp at Tap: 2°C (36°F)	For Commercial Use Indoors

## SETUP

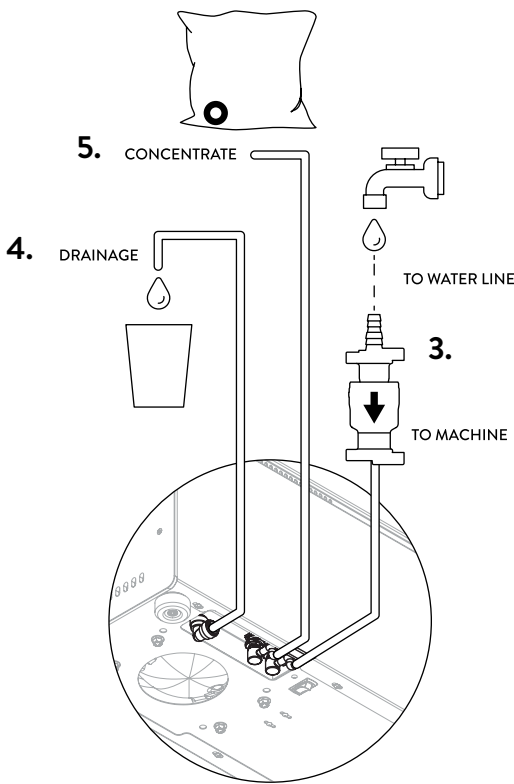

1. **Install on clean dry surface.**
  - Allow no less than 5 centimetres of space from all sides.
2. **Plug the power cord into an electrical outlet.**
3. **Attach a water line to the pressure reducer's inlet, located at the exposed ¼" barb on the tail end of the reducer.**
  - Ensure the tube is securely tightened and fastened with a crimp.
  - Turn on the water supply.
4. **Connect the drain tube to an empty container with a capacity at least equal to that of the Bag-in-Box (BiB) Concentrate.**
  - This serves as a safety measure in case of overflow.
5. **Connect the Beverage Tube to DRNX MIX by pushing the elbow fitting into the connection underneath the machine.**
  - Tilt the machine slightly if you need to. If you need to release the beverage tube, push the metal spring next to the connection underneath.
6. **Connect the Beverage Tube to the BiB. Follow the provided instructions below if using a Scholle Quick Connect Adapter.**

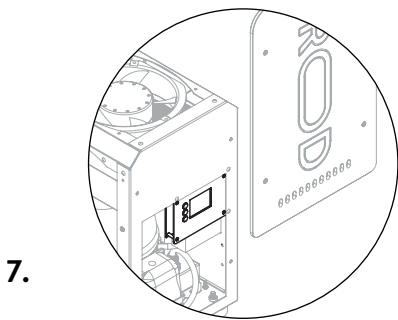

7. **Remove the back panel to access the Ratio Controller using a standard Philips drive.**
8. **Screen Unlocking:**
  - To unlock the screen, press the center button three times consecutively, followed by a single press of the bottom button. Note that the screen will automatically re-lock after 30 seconds.
9. **Dialling in Ratio Pump:**
  - Adjust the Ratio Pump settings to match your desired preference, keeping in mind that the highest achievable setting is 130.

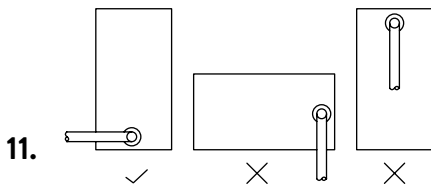

10. **Understanding Ratio Settings:**
  - For reference, a setting of 005 indicates less dilution, resembling a 1:1 ratio. As you progress towards 130, more water dilution occurs, resulting in less concentrate being pumped. Changes in ratio will only be noticeable after pouring approximately 500mL into a cup.

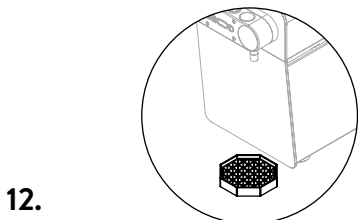

11. **BiB Concentrate Placement:**
  - When using concentrate in a BiB, it's crucial to position the BiB outlet downward, not upwards. This arrangement ensures an uninterrupted flow of concentrate and eliminates potential air pockets within the BiB.
12. **Place Drip Tray beneath the spout.**

## CONNECT TO CONTAINER

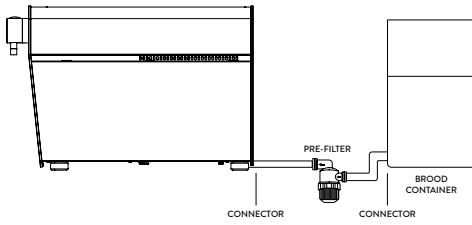

### Connecting to the designated BROOD container.

1. Pour your beverage into the designated container. Close the lid and push the seal.
2. Push one of the elbow fittings into the connector at the bottom of the container. And push the other fitting into the connector at the bottom of the machine.
3. Make sure the arrow at the base of the pre-filter is pointing in the direction of the flow. (Towards the machine)

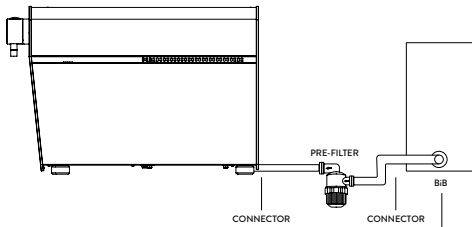
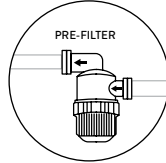

### Connecting to BiB with a Scholle QCD adapter

1. Twist the QCD adapter onto the BiB outlet. Make sure the connection is sealed.
2. Make sure the arrow at the base of the pre-filter is pointing in the direction of the flow. (Towards the machine)

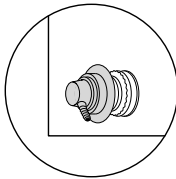

**WARNING:** Liquid containing solid matter cannot be used.

**WARNING:** Never run hot liquid above 30°C (86 °F) through DRNX MIX.

**CAUTION:** Beverage container must be level with the machine.

## STEPS

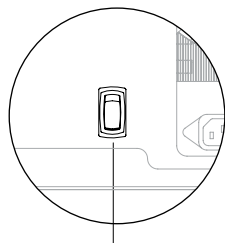

MAIN ON/OFF SWITCH  
ON BOTTOM OF MACHINE

1. Switch on the main ON/OFF button at the bottom of the machine.
2. Place your cup beneath the stout at an angle for the best pour.

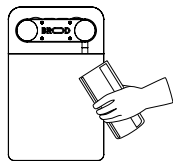

3. **Priming:** Press and hold the mushroom capped button at the bottom of the machine for 5 seconds. This procedure should be repeated every time an empty concentrate BiB is replaced with a new one.

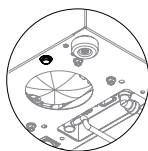

4. **First Pour:** Press the black capped button, or pull the tap handle down to dispense 32 oz. of liquid to effectively prime the machine. It is important to keep pouring until the beverage from the spout is flowing normally. Expect a small spurt of air that might come from the spout during this process. Keep the glass raised high and close to the spout to contain it.

Changes in ratio will only be noticeable after pouring approximately 500mL into a cup.

5. To pour a **NITRO** beverage, press “INFUSION”.  
To pour a **STILL** beverage, de-press “INFUSION”.

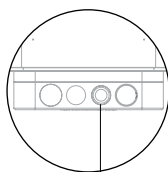

INFUSION BUTTON  
OFF  
(NO LIGHT)

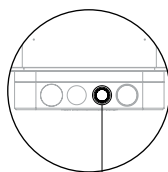

INFUSION BUTTON  
ON  
(LIGHT)

Please note, if the last pour was nitro cold brew and the operator wants the next pour to be still cold brew, there will be less than 5 mL (0.34 oz) of nitro cold brew in the tap that will come out. Every subsequent still cold brew pour will come out fully still, until the next nitro cold brew pour.

6. Press the black capped button, or pull the tap handle down to start pouring, and release it when the pour has been completed.
7. If water is dispensed from the tap, it signals that the Bag in Box (BiB) is empty, and the machine is currently dispensing only water.







Make sure the pre-filter adapter is installed in the beverage tube.  
Ensure that the coffee is filtered with a fineness of at least 100 µm (microns).  
Not using the pre-filter risks damaging the internal components of DRNX MIX.

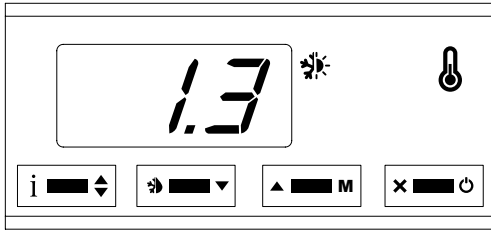



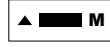

## TEMPERATURE CONTROL



-  Info / Setpoint button.
-  Manual defrost / Decrease button.
-  Increase / Manual Activation button.
-  Exit / Stand-by button.

### MODIFICATION OF DESIRED TEMPERATURE VALUE

Press button  for at least half second, to display the setpoint value.  
 By keeping button  pressed, use button  or  to set the desired value.  
 When button  is released, the new value is stored.

**If the operator sets the temperature at freezing, it runs the risk of freezing the Cold Brew. If this happens, turn off the fridge as described in step 2. Keep off for 2 hours.**

## NITROGEN CALIBRATION

**If the level of nitrogen infusion is too high, then follow the steps below to decrease the level of nitrogen infusion. This is a one-time calibration process to adjust the amount of infusion at the maximum position only.**

1. Locate and remove the four screws in the back panel.
2. Locate and remove the two screws underneath the machine on the left side.  
 Only tilt the machine slightly when unscrewing from the bottom. Tilting the machine too much may damage the compressor. The best practice is to bring the machine close to an edge to gain access to the two screws underneath.
3. Locate and remove the two screws underneath the machine on the right side following the same instructions as the previous step
4. Pull the bottom of each side panel outward and slide it back to release it.
5. Locate and remove the two screws on each side that fasten the top panel, to lift it completely off the machine
6. Identify the calibration knob. Turning it clockwise will decrease the amount of nitro.
7. Return the top panel and screw it securely.
8. Return the side panel and screw it securely from underneath the machine.
9. Return the back panel and screw it securely.

## INSTRUCTIONS

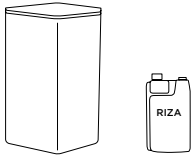

### 1 STEP DILUTION PROCESS RINZA

CONTAINER SIZE	CLEANER/SANITIZER	WATER
3Liter	180 mL	3Liter

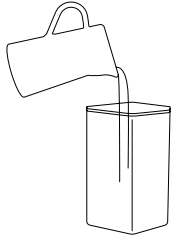

1. Fill the container with 1.5L of clean water



5. Rinse the container with clean warm water

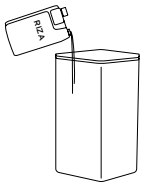

2. Add 180 mL Rinza Solution to the container and fill with an additional 2.5L of clean water. Measure carefully.

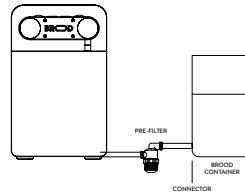

6. Fill the container with clean water, then run 3L of fresh water through the tap before re-attaching your cold brew BiB.

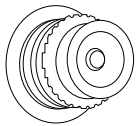

3. Detach the QCD Adaptor from the Bag in Box (BiB) and replace it with a “pink cap.” Then, place the assembly into the container. The “pink cap” serves to open the valve within the QCD Adaptor, allowing the flow of Rinza Solution through the beverage tube.

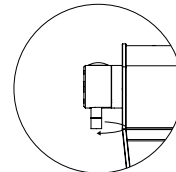

7. Unscrew the tip of the spout, and rinse.

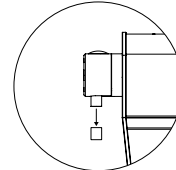

4. Place an empty container under the tap spout. Run the solution through the system for 40 seconds and let stand for 15 minutes. Remove the ventilation tube from the container. Then run the remaining solution through the system.

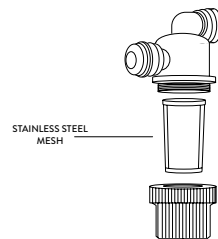
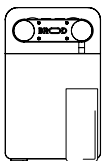

8. Unscrew the cover of the pre-filter by turning it counter-clockwise. Remove the stainless steel mesh and wash with clean hot water. Make sure the stainless steel mesh is not clogged.

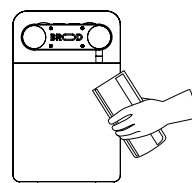

9. **BEFORE SERVING:** Place a glass under the tap. Pull the tap down until the water is flushed out and cold brew begins to flow freely, then close the tap.

## QUICK SOLUTIONS

There is too much nitro	The calibration knob is not set correctly.	Follow steps in to decrease the level of infusion outlined in section “Nitrogen Calibration”
<b>Pouring Issue</b>  Any issue related to a bad pour is due to a restriction in the tubes. This can be isolated to either the beverage tube going into the machine, or inside the machine itself.	1. Can the pump be heard running, but nothing, or very little comes out of the spout?	If YES, there is a restriction in the beverage line going into the machine. A) If using a keg, ensure it’s not pressurized. B) Check for kinks in the beverage tube where it connects beneath the machine. Ideally, have the beverage tube come from behind the machine around the back leg. C) Inspect the pre-filter for blockage by unscrewing it and cleaning the stainless-steel mesh inside. Alternatively, bypass the pre-filter by disconnecting the tube from the pre-filter and placing it in a container of water. If the machine pours normally, the pre-filter is likely the issue. D) Ensure the pre-filter isn’t reversed; it is directional, with a small arrow indicating the flow. E) Check that the white elbow connecting to the machine is fully inserted and clipped in place. F) Check that the white elbow connecting to the container is fully inserted and clipped in place.
	2. Does the pump shut off the moment the pour button is pressed?	If YES, there’s a blockage after the pump. To troubleshoot: A) Turn off the machine for 4 hours to defrost any ice in the line (if present). B) Unscrew the spout tip to check for blockage. Try pouring with the spout off. C) Pour a cleaning solution through the machine and let it soak overnight to lubricate and dislodge any buildup in the Module. D) If the issue persists, reverse flush the Nitro Infusion Module. Please follow <a href="#">this link</a> for instructions on how to reverse flush the Nitrogen Infusion Module.
	3. Is the flow on the NITRO setting normal, but lacking foam?	If YES, the Nitrogen Infusion Module requires cleaning. To troubleshoot: A) Pour a cleaning solution through the machine and let it soak overnight to lubricate and dislodge any buildup in the Module. B) Unscrew the spout tip to check for blockage. Try pouring with the spout off.
	4. Is the beverage spraying out of the spout?	If the beverage sprays from the spout, it indicates a blockage. To address this, unscrew the cap and rinse it thoroughly.
	5. Does liquid continuously drip out of the spout?	If the liquid is dripping from the spout, it indicates that either the Bag-in-Box (BiB) or container is empty, or the BiB/Container is positioned above the machine.
Too many large bubbles	Beverage tube is not pushed in firmly.	Release the elbow fitting by pushing the spring underneath DRNX and reconnect. If using a keg or a Bag-in-Box make sure that the coupler is secured firmly.
Product is not cold enough.	The temperature setting is too high.	Check to see if the main switch underneath the machine is on. Follow the instructions in the manual to change the temperature setting.
	The cold brew in the container is too hot.	The variance between the cold brew in your container and at the tap is 20°C. This means if your cold brew is 22°C (room temperature), then the nitro cold brew at the tap will be 2°C.
	Pause for a moment between pours.	If pouring more than 1.5 litres (48oz.) continuously and without stopping, then it might be necessary to pause for a few minutes for the exhaust fan to turn off until pouring a subsequent drink.

**Q. I JUST RECEIVED MY DRNX MIX, HOW DO I SET IT UP?**

A. Please follow the instruction manual that comes with DRNX MIX. It is easy to set up!

**Q. WHERE DO I PUT MY COLD BREW COFFEE OR TEA?**

A. DRNX MIX can pull cold brew from any container. DRNX MIX comes with a beverage tube that clips into the dispenser from underneath. The other end is loose so that an operator can drop it into any container. Alternatively, an operator can attach a keg coupler, bag-in-box adaptor, or an elbow fitting to the other end of the beverage tube in order to connect it to a keg, bag in-box, or BROOD container respectively. Please watch our instructional video on our website.

**Q. I AM GETTING LARGE BUBBLES IN MY NITRO COLD BREW, WHAT SHOULD I DO?**

A. Make sure all the tubes are pushed in firmly and there is no air seepage. Observe if there are any air bubbles flowing through the beverage tube. Air that seeps into the tubes will ultimately come out at the tap in the form of air bubbles. This will also happen if your beverage tube is sucking in air from a loose connection. The quality of the cold brew also has a marked effect on the size of the bubbles in the final head of the drink. The more filtered the cold brew, the smoother the surface of the head.

When pouring, make sure that cup is always at an angle and the stream from the spout hits the inner wall of the cup.

**Q. MY BEVERAGE IS NOT COLD ENOUGH, HOW DO I MAKE IT COLDER?**

A. Follow the instructions in section “Temperature Control” on page 6 to decrease the temperature.

**Q. DRNX MIX IS NOT POURING COLD BREW, WHAT SHOULD I DO?**

A. There are several reasons why this may happen. All of them are easily remedied. Please follow our troubleshooting guide in this instruction manual.

**Q. WHEN I POUR MANY GLASSES OF NITRO COLD BREW CONTINUOUSLY, THE FOURTH ONE IS SOMETIMES SLIGHTLY LESS CHILLED THAN THE FIRST ONE. WHY IS THAT?**

A. We recommend pouring for 45 seconds which is about 1 litre (32oz.) and then pausing for a few moments until the exhaust fan switches off. This means the cold brew inside the fridge has been chilled to your desired temperature.

**Q. DRNX MIX HAS A SOUND THAT COMES AND GOES, WHY?**

A. This is the sound of the exhaust fan. When this sound is heard it means that the fridge is cooling down to the pre-set temperature. When the sound stops this means that the compressor has also stopped as the desired temperature has been reached.

**Q. I HAVE THE FRIDGE SET AT THE COLDEST POSSIBLE TEMPERATURE, BUT THE BEVERAGE IS NOT COLD ENOUGH, WHY IS THIS?**

A. The variance between the cold brew in your container and at the tap is 22°C. This means if your cold brew is 24°C (room temperature) then the nitro cold brew at the tap will be 2°C. Never use cold brew or any other liquid that is warmer than room temperature.

**Q. DO I NEED TO KEEP A GAP AROUND THE VENTS ON THE TOP OF DRNX MIX?**

A. Yes, never cover the exhaust located on top of the machine. If covered, it may damage the compressor.



**The warranty period is 1 year. Please review our warranty terms and conditions.**

In order for the products to be stable, long lasting, AND covered under this manufacturer's warranty, these requirements must be met:

DRNX MIX is designed to be installed in interior areas with relative humidity levels of 35%-60% and operate at temperatures between (13°C - 32°C). DRNX MIX must be stored at temperature between (13°C - 40°C). Prior to opening original packaging or installation material, ensure that the spaces are enclosed and completely weatherproof, and the building temperature and humidity conditions are consistently maintained at the indicated levels. The product **MUST** be stored in an environmentally controlled space at all times. Do not store the product in direct sunlight.

### **THIS WARRANTY DOES NOT COVER:**

- Any machine NOT distributed by BROOD Refreshments Company Ltd.
- Any machine NOT purchased from an Authorized BROOD Dealer (email us at [hello@drinkbrood.com](mailto:hello@drinkbrood.com) to check for authorized dealers or check our website at [www.drinkbrood.com](http://www.drinkbrood.com)).
- Damage caused by accident, abuse, negligence, or misuse.
- Improper operation or failure to follow instructions contained in the manual.
- Any service or alteration performed by an unauthorized person, company, or association.
- Damage caused by neglecting to clean and/or maintain upkeep of DRNX MIX.
- Damage caused by use of undissolved instant coffee or any other ingredients not allowed in the dispenser.

This warranty is not transferable and applies to the original purchaser only.

The warranty period begins on the delivery date. If our transportation, storage or installation instructions are not followed, any warranty shall lapse. The warranty period is 1 year. The purchaser must inform BROOD Refreshments Company Ltd in writing of any transportation damages without delay, but at the latest within one week of arrival of the equipment. The purchaser must cease any processing or handling of the damaged units. BROOD does not accept any guarantee against defects which are due to improper storage or use of the products. The storage and use of the products presuppose that full knowledge and experience of the technology is taken into account to avoid detrimental effects on the quality and stability. This warranty does not cover damage caused by improper maintenance or by use contrary to our recommendations. There are no implied warranties, representations or conditions, except those required by statute, and they shall not extend beyond the term of the warranty applicable to your purchase.

### **CLEANING IS A CRITICAL PART OF MAINTAINING THE LONGEVITY OF DRNX MIX**

- Prior to installation, use a clean soft cloth that has been dampened to remove dust or other foreign materials from panel surfaces. Dirt and grit should not be allowed to build up as these may scratch the finish during setup.
- Do not apply soap or cleaner directly to panel surfaces. Apply water to cloth and then wipe panel surfaces.
- Do not apply any solvents to panel surfaces, even by transfer from a cleaning cloth.
- Damage from solvents may not be immediately noticeable upon application. Do not use brushes to clean panels or vents as bristles will scratch panel surfaces.
- Daily flushing of DRNX MIX as outlined in the operation manual is required.
- Cleaning DRNX MIX consistently is crucial to the operation and lifespan. Any negligence in daily cleaning and upkeep of DRNX MIX will risk damaging the machine over time. The warranty period is 1 year. Please review our warranty terms and conditions. To make a warranty claim, please email [hello@drinkbrood.com](mailto:hello@drinkbrood.com). For faster service, locate the model type and serial number, and include them in your email.



**To make a warranty claim, please email [hello@drinkbrood.com](mailto:hello@drinkbrood.com). For faster service, locate the model type and serial number, and include them in your email.**

## STORAGE

Before placing DRNX MIX out of service for a period longer than 2 weeks, we recommend the weekly cleanse as per the instructions in the Care section. Store DRNX MIX in a dust-free environment between 13°C and 40°C.

## DISPOSAL

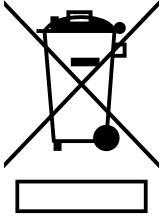

The packing materials can be recycled. Unplug the appliance and the power cord. Deliver the appliance and power cord to a service centre or public waste disposal facility. This product may not be treated as household waste. Instead it shall be handed over to the applicable collection point for the recycling of electrical and electronic equipment. By ensuring this product is disposed of correctly, you will help prevent potential negative consequences for the environment and human health, which could otherwise be caused by inappropriate waste handling of this product. For more detailed information about recycling of this product, please contact your local city office, your household waste disposal service or the shop where you purchased the product.